

DC Jack (DCJ-05T-2.0P):



SPECIFICATIONS

Power Rating:	3.5A/30V DC Max.
Operating Temperature:	-25°C ~+85°C
Relative Humidity:	93%, +40°C
Dielectric Withstanding:	500V AC/minute
Contact Resistance:	≤ 30 mΩ/Contact
Insulator Resistance:	≥ 100 MΩ at 500V
Action Force:	3N-30N
Life Time:	5000 times
Material:	
Base:	PBT/Nylon6T, UL94V-0
Contact Pin:	Brass / Copper Alloy
Contact Plating:	Tin plated

ROHS Compliance

DCJ-05T-2.0P

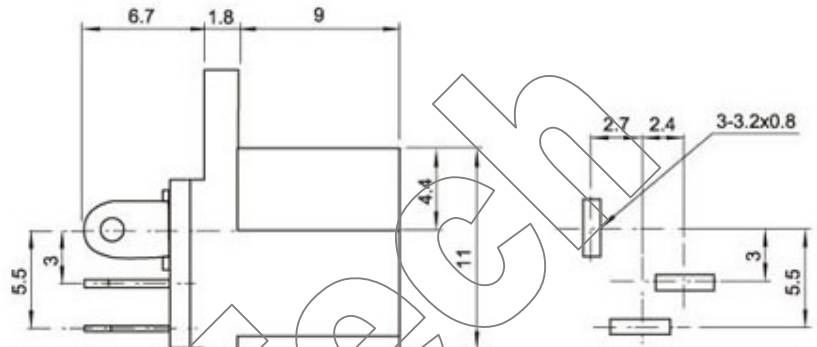
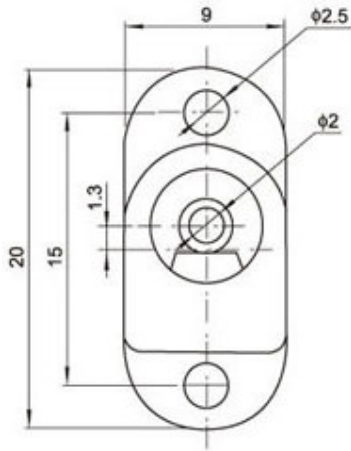

Recommended PCB layout

