

**2.5mm Phone Jack (PJ-2.5S-8821H):**



**SPECIFICATIONS**

Power Rating:	1.5A/30V DC Max.
Operating Temperature:	-25°C ~+85°C
Relative Humidity:	93%, +40°C
Dielectric Withstanding:	500V AC/minute
Contact Resistance:	≤ 30 mΩ/Contact
Insulator Resistance:	≥ 100 MΩ at 500V
Action Force:	3N-20N
Life Time:	5000 times
Material:	
Base:	PBT/Nylon6T, UL94V-0
Contact Pin:	Brass / Copper Alloy
Contact Plating:	Tin plated

**ROHS Compliance**

**PJ-2.5S-8821H**

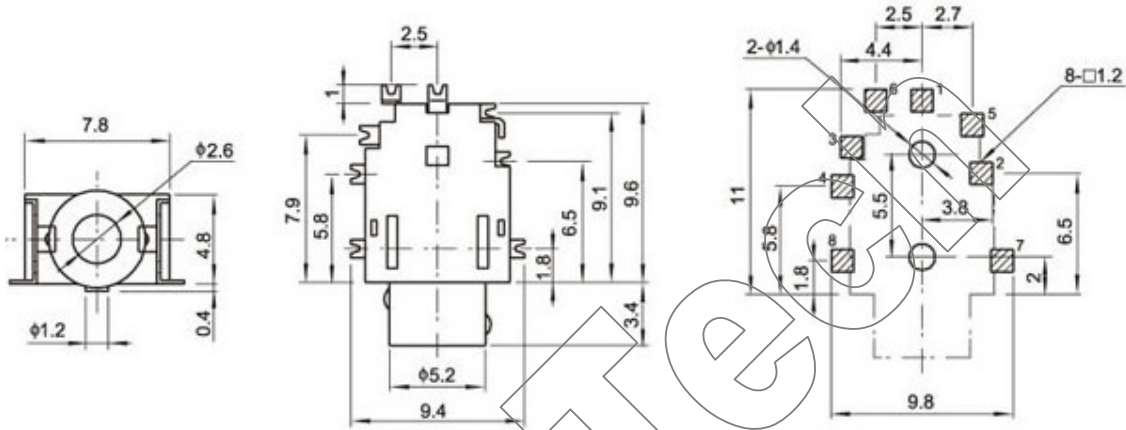

Recommended PCB layout

